

CAPP

CR-68X



USER MANUAL

CONTENTS

1.	INTRODUCTION	1
2.	INTENDED USE	1
3.	FEATURES	1
4.	TECHNICAL SPECIFICATIONS	2
5.	STANDARD ACCESSORIES	2
6.	SAFETY PRECAUTIONS	2
7.	INSTALLATION	3
8.	STANDARD PART LISTING	4
9.	ROTOR BALANCING	4
10.	INTERCHANGEABLE ROTOR	5
11.	CHANGING THE ROTOR	5
12.	OPENING CENTRIFUGE LID	6
13.	OPERATION	7
14.	CARE AND MAINTENANCE	10
15.	WARRANTY STATEMENT	10
16.	PRODUCT DISPOSAL	11

1. INTRODUCTION

This Micro Centrifuge offers versatility, simplicity, safety, and ease of usage in a single package. This product has been designed after studying centrifuges and its usage in numerous scenarios of the lab environment.

This Micro centrifuge is specially suitable for microfiltration, cell separations, centrifugal tube sedimentation, and spin down applications. Please read this manual thoroughly before operating the centrifuge.

2. INTENDED USE

This Micro Centrifuge is used in various laboratories to separate particles from suspension or even macromolecules from solutions according to their density. The different biological substances that are usually separated by centrifugation are microbial cells, organelles, proteins, DNA, and RNA.

Note : *This user guide is intended to assist with the operation and care of the nit only and not for its repair. The customer should not attempt to service or repair the unit. If repairs are required, please contact the supplier.*

3. FEATURES

- BLDC motor for maintenance free long life
- 8 Position closed micro tube rotor
- Closed rotor leads to lesser friction, reducing noise & heat generation
- Digital display
- Highly efficient & accurate
- Electronic safety brake on lid opening for user safety
- Quick start & stop for short spin
- Smooth and quiet running
- Tiny footprint : It can squeeze easily on to a crowded counter top
- Interchangeable PCR rotor & adaptor
- Low voltage instrument with external power adaptor
- Speed and time setting function
- Digital timer programming function
- Variable speed settings RPM Increments At 100 rpm
- Imbalance cut off for safety

4. TECHNICAL SPECIFICATIONS

Motor Type	Brushless DC Motor
Rotor Capacity	8 x 1.5 /2.0 ml Tube Rotor & 2 Place PCR Strip Rotor
Speed Setting	2000 - 6000 RPM
	2000 x g (MAX RCF)
Speed Accuracy	± 25 RPM
Time	0 To 25 Mins & Infinite
Size (w X D X H)	162 x 157 x 116 mm
Weight	1.1 Kg
Input Voltage	24V $\overline{\overline{\cdot}}$ 0.62A
Power Consumption	15W

5. STANDARD ACCESSORIES

- 1.5/2ml closed rotor
- PCR strip rotor
- Allen wrench
- Individual adaptor for 0.5 ml tubes, pack of 8
- Individual adaptor for 0.1 / 0.2 ml tubes, pack of 8
- Power Adaptor: Input voltage-100-240VAC 50/60Hz
Output voltage: 24V $\overline{\overline{\cdot}}$ 1.5A
- Product User Manual, Warranty Card and Declaration Conformity

6. SAFETY PRECAUTIONS

The personal micro centrifuge is designed to be safe under the following conditions when operated with necessary precautions mentioned below :

- Indoor use only.
- Ambient temperature of 4°C to 45°C.
- Main supply voltage fluctuations not to exceed +/- 10% of the nominal voltage.
- Position at least 20 cm from walls, 20 cm from ceiling and 20 cm between other products.
- Make sure to always install the centrifuge on stable flat surfaces only & place it near the electrical outlet.
- Always load the rotor symmetrically. Each tube should be counterbalanced by another tube.

- Make sure to always use only specified micro centrifuge tubes made from plastic and designed to withstand centrifugal forces of at least 2000 g.
- Do not operate the centrifuge without the rotor being properly attached to the shaft. Re-check by trying to pull it up manually, especially after the rotor has been changed or re-assembled.
- Do not move the centrifuge while it's under operation.
- Do not fill the tubes while they are in the rotor. Liquid spillage may harm the unit.
- Do not put hands in the rotor chamber unless the rotor has completely stopped.
- Do not centrifuge flammable, explosive or corrosive materials.
- Do not use solvents or flammable media near this or other electrical equipment.
- In case the unit is dropped from the table, please check the casing for any cracks/damage.
- The centrifuge and its components are non autoclavable.
- Do not use the centrifuge in any manner not specified in these instructions.

7. INSTALLATION

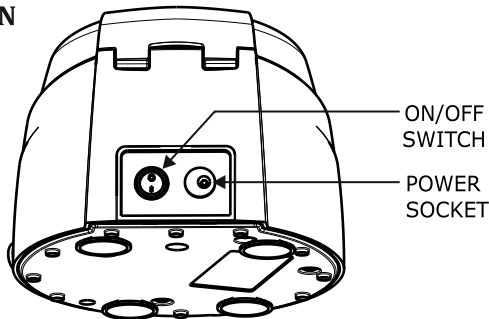

This Micro Centrifuge is supplied in a packaging box. Open the box, then gently remove the centrifuge from the box and plug in the power adaptor pin before connecting to the main power source. The instruction manual and the accessories should be kept with the centrifuge. Please keep all packaging in safe storage for at least 2 years for warranty purposes.

Make sure the rotor is tight to avoid any accident. Load the rotor with the micro tubes for centrifugation. Place the ON/OFF switch to “o”, rear, set the desired speed and time, and close the lid to start centrifugation.

For more clarification refer to the RCF chart below:-

RCF CHART					
RPM	ROUND ROTOR				PCR STRIP
	0.2 ml	0.5 ml	1.5 ml	2 ml	0.2 ml
1000	35.5	47	52	54	52
2000	142	188	208	217	208
3000	319	424	468	488	467
4000	567	753	832	868	830
4500	718	953	1053	1098	1050
5000	886	1177	1300	1356	1297
6000	1276	1695	1872	1952	1868

8. STANDARD PARTS LISTING

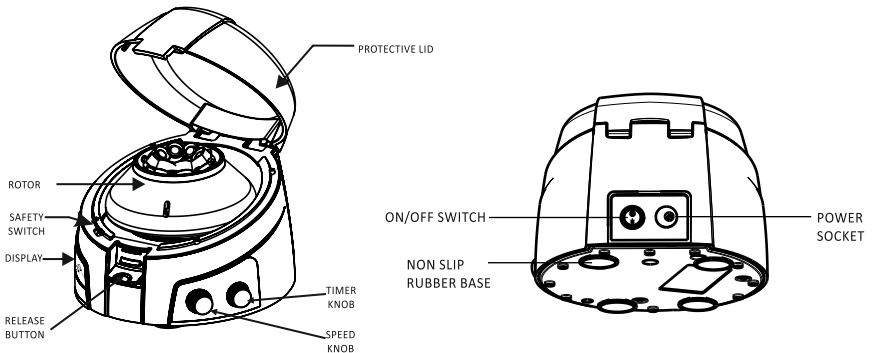

9. ROTOR BALANCING

1. Always balance the rotor before centrifugation. The following are asymmetrical loadings of centrifuge tubes to the rotor.

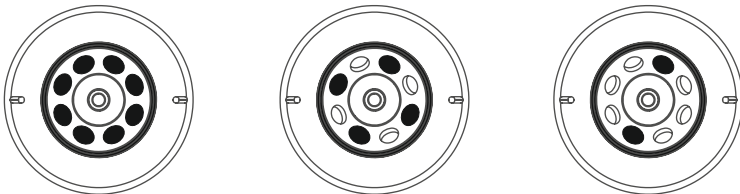

2. Ensure that the samples in the tubes are of equal volume.
3. Symmetrical loading of tubes in the rotor is necessary, otherwise vibration or imbalance can occur which can cause serious damage to the centrifuge.

4. If the tubes are not loaded symmetrically then the imbalance detector will cut off the running centrifuge for device & user safety.
5. The following are the incorrect methods of loading tubes in the centrifuge the rotor.

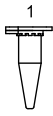
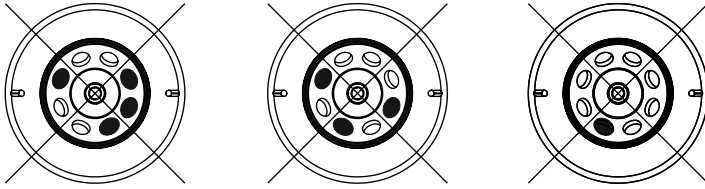

0.2 ML

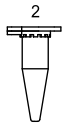

0.4 ML

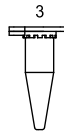

0.5 ML



1.5 ML / 2.0 ML

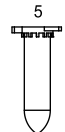

1.5 ML / 2.0 ML



1.5 ML / 2.0 ML



1.5 ML / 2.0 ML

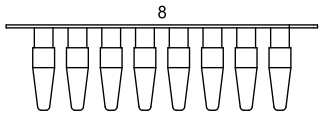

PCR STRIP

8 Different types of test tubes can be centrifuged by using two interchangeable rotors

10. INTERCHANGEABLE ROTOR

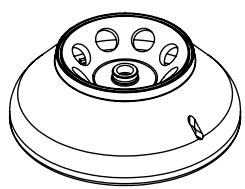

ROTOR_8 SLOT
8 x 0.2,0.4,0.5,1.5,2 ml

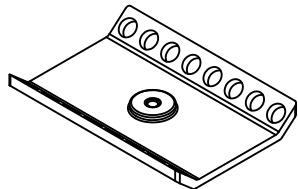

PCR ROTOR
16 x 0.2 ml

11. CHANGING THE ROTOR

Insert the hexagonal allen key into the marked hole provided on the side of the rotor. The grub screw is located at the bottom of the rotor on the marked side. To remove the rotor, turn counter - clockwise to loosen the screw and then gently pull the rotor up vertically. Insert the new rotor from the top onto the motor shaft and tighten the

screw again. Turn clockwise to tighten the screw which is located under the bottom of rotor. Please check that the rotor is tight enough to avoid any accidents.

Note: Tightening the screw will be in clockwise direction and the loosening will be in counter-clockwise direction

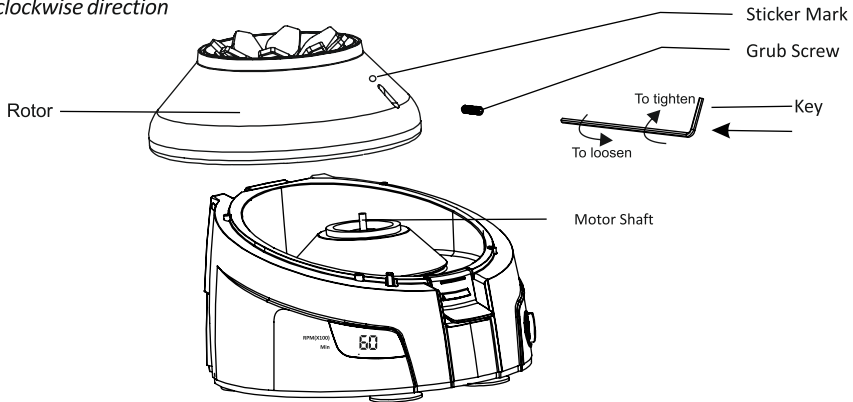

12. OPENING CENTRIFUGE LID

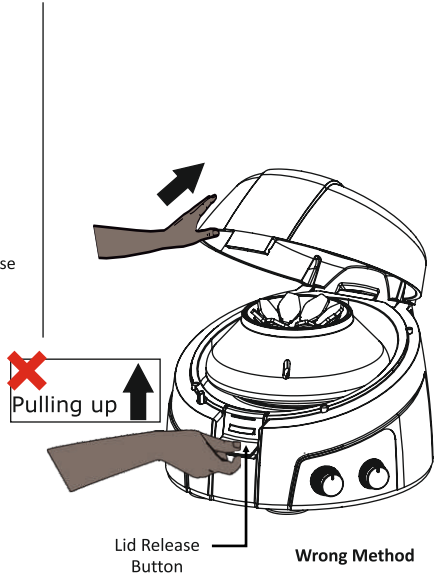
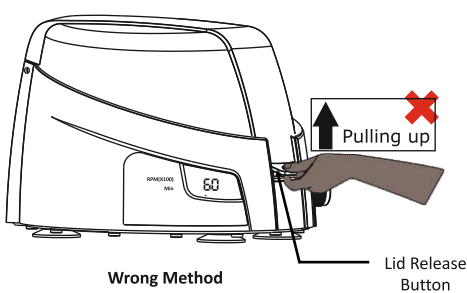

Trying to open the centrifuge lid by pulling the “Lid Release” button up is the wrong method of opening the lid. Pulling the “Lid Release” button up will break the button or damage the button.

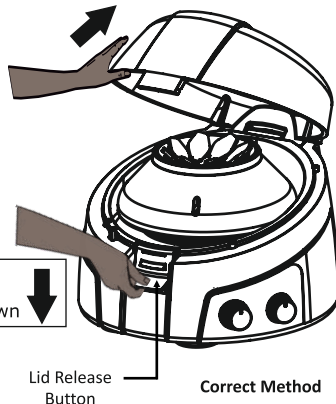
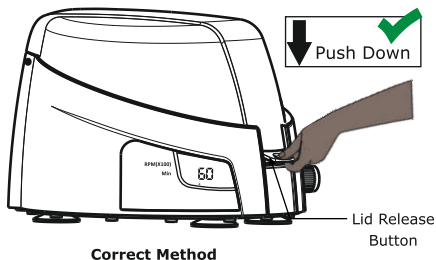

To open the centrifuge lid, press the “Lid Release” button down.

13. OPERATION

To operate this Micro Centrifuge, the below steps should be followed:

1. Connect the power adaptor & Switch ‘On’ from the rear side so that the display will show you the fix RPM readings.
2. Load the rotor symmetrically to avoid accidents and damage to the centrifuge.
4. Close the lid & flip ON the front switch to start centrifugation.
5. Once the centrifugation is completed, turn the front switch to “Off” to gradually stop the rotor.
6. After the rotor has stopped, press the lid release button and open the lid with your thumb in front and fingers on the top - simply lift the lid back on the hinge.
7. If you want to stop the centrifuge quickly, push the lid release button and the rotor will stop within a few seconds.

In the following pages the routine centrifuge operation procedures are explained in brief.

TIME & SPEED SETTINGS AND DISPLAY

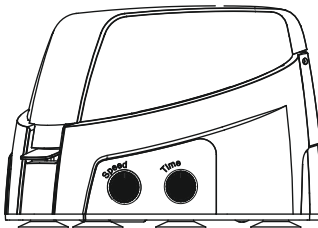

TIME CONTROL, SPEED CONTROL AND DISPLAY

The unit is equipped with a 0-25 minutes timer. By operating the timer knob one can set the desired time cycle. The time increments/ decrements will be in minutes and will show on display and indicator.



Time indicator display

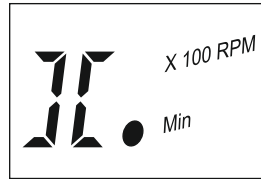

Infinite time display

The timer can be set from 00 to 25 minutes. If the user needs to operate without time control he can change it to next position after 25, here it will be set to infinite time “ II ”. The timer used is a count down timer and can be reset or adjusted in between the runs. 00, actually means stop position of centrifuge.



Speed indicator



Time indicator

During the running of centrifuge the time and speed will be displayed alternatively accompanied by speed indicator and time indicator respectively.

Quick spin function: By keeping the timer to “II” position and speed set to any desired setting, one can open and close the lid to operate the centrifuge in quick spin function mode.

Speed control: Speed is set by rotating the speed control knob. While adjusting the speed, the speed indicator comes on. The minimum increment or decrement will be to the order of 100 RPM. The speed indicator must be read with a multiplication factor of 100 to get the actual rpm.

RCF value: Based on the speed and rotor the actual RCF value will vary. One can refer to the table (mentioned in the section 7) to get the actual RCF of different rotors at certain given speed values.

IMBALANCE DETECTION ACTIVATION/DEACTIVATION

When you switch `On` the centrifuge either it shows “En” or “dS”

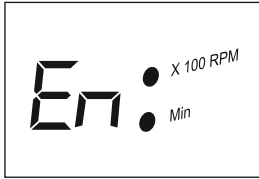

Imbalance activated display

If the display shows "En" that means the imbalance detection is activated

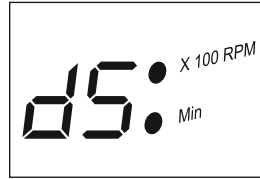

Imbalance de-activated display

If the display shows "dS" it means the imbalance detection is de-activated

User can activate and deactivate the unbalance detection function by long pressing the timer knob as shown in above picture. The display will change to show "En" or "dS" to show active status.

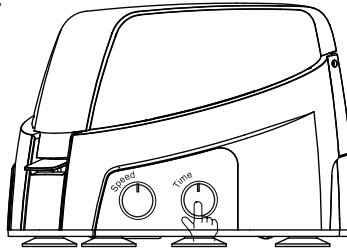

UNBALANCE DETECTION AND CUT OFF

When imbalance detection is activated "En"& if centrifuge is running with an unbalanced rotor, (by not placing the weights on the rotor equally and symmetrically) it may lead to excessive vibrations resulting in damage to the centrifuge. This centrifuge has an unique patented feature to protect the centrifuge, its user & the surroundings against such as accidental run. When such an event occurs, the sensor build inside the centrifuge will trigger the shut down of the centrifuge and will also indicate the event by flashing ' Ub' :

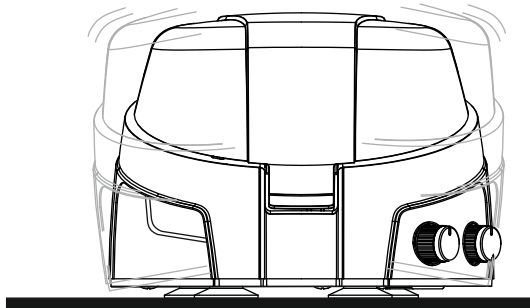

User action:

Open the lid of centrifuge, correct the unbalanced load by various methods described in the balancing the rotor part of this manual. Then close the lid and 'reset the centrifuge'. Resetting is done by switching 'Off' and again switching 'On' the centrifuge by using the On/Off switch located on the rear side of the centrifuge.

14. CARE & MAINTENANCE

This personal centrifuge and its rotor should be cleaned periodically. Ensure that while cleaning the unit, it is not plugged in to the main power supply. To clean this centrifuge, use a damp cloth and a mild, noncorrosive detergent (ph < 8). Do not immerse the centrifuge in liquid or pour liquid over it. Excessive amounts of liquid should be avoided, liquid should not come into contact with the motor. After cleaning, ensure all parts are dried thoroughly before attempting to operate the unit.

Should a spill of infectious materials occur within the rotor or rotor chamber, the unit should be disinfected. This should be performed by qualified personnel with proper protective equipment. Do not use any cleaning or decontamination methods except those recommended by the manufacturer. Check with the manufacturer that the proposed method will not damage the equipment.

15. WARRANTY STATEMENT

This product is warranted to be free from defects in material and workmanship for a period of two (2) years from date of purchase. Your product will be duly repaired upon prompt notification in compliance with the following conditions :

This warranty is valid only if the product is used for its intended purpose and within the guidelines specified in this instruction manual. This warranty does not cover damage caused by accident, neglect, misuse, improper service, natural forces or other causes not arising from defects in original material or workmanship. This warranty does not cover any incidental or consequential damages, commercial loss or any other damages from the use of this product.

The warranty is invalidated by any non-factory modification, which will immediately terminate all liabilities on us for the products or damages caused by its use. The customer shall be responsible for the product or use of products as well as any supervision required for safety. If requested the products must be returned to the distributor in well packed and insured manner and all shipping charges must be paid.

***Note:** Some states do not allow limitation on the length of implied warranties or the exclusion or limitation of incidental or consequential damages. This warranty gives you specific legal rights. This warranty is given expressly in lieu of all other warranties, expressed or implied.*

The purchaser agrees that there is no warranty of merchantability or of fitness

for any intended purpose and that there are no other remedies or warranties, expressed or implied, which extend beyond the description on the face of the agreement. This warranty is only applicable to the original purchaser.

Products received without proper authorization will not be processed for warranty or service. All items returned for service should be sent with postage prepaid in the original packaging or other suitable packaging, padded to avoid damage. We will not be responsible for damage incurred by improper packaging.

Note: *This warranty is valid only if the warranty is registered with the supplier within 30 days from the date of purchase.*

16. PRODUCT DISPOSAL

In case the product is to be disposed of, the relevant legal regulations are to be observed.

Information on the disposal of electrical and electronic devices in the European Community

The disposal of electrical devices is regulated within the European Community by national regulations based on EU Directive 2012/19/EU on waste electrical and electronic equipment (WEEE). According to these regulations, any devices supplied after 13.06.05 in the business to business sphere, to which this product is assigned, may no longer be disposed off in municipal or domestic waste. They are marked with the following symbol to indicate this.

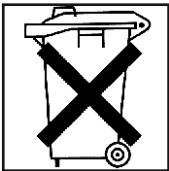

As disposal regulations within the EU may vary from country to country, please contact your supplier if necessary.

For your reference, make a note of the serial number, date of purchase and supplier here.	
Serial No.	Purchase Date
Supplier	



Uthleber Weg 14, 99734, Nordhausen, Germany
Telefon +49(0)3631 65242-0 • Fax +49(0)3631 65242-90
www.capp.dk / info@capp.dk